

Product Description:

The CANIS-J2 Series is a strong alternative to the original CANIS-J, now available with adjustable wattage and CCT. It has a strong aluminum frame that is anti-corrosive and provides quick heat dissipation. The CANIS-J2 utilizes a LGP lens that is ultra-thin, provides uniform lighting and good insulation. The LGP lens has prominent aging resistance and chemical stability thus insuring anti-yellowing over the luminaire's lifespan.



Features:

- › **Application:** LED Flat Panel
- › **Installation:** Ceiling / Recessed / Suspended
- › **Warranty:** 5 Years
- › **Operating Temperature:** -22°F ~+ 122°F
- › **CRI:** >80

Technical Data:

Certifications	UL
CRI	≥ 80
IP Rating	IP40
CCT	3000K-5000K (Adjustable)
Input Voltage	100-277V

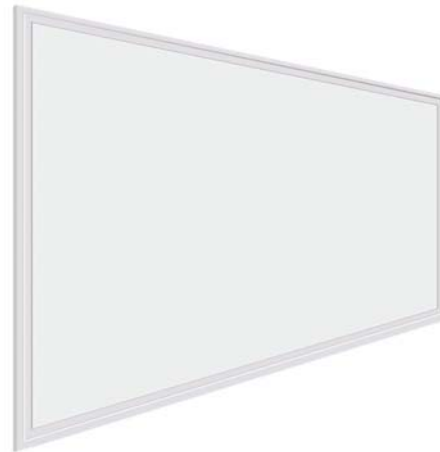

Specifications:

Fixture Model*	Total Lumens*	Efficacy (lm/w)	Dimensions (inches)	Weight (lbs)	Beam Angle
CANIS-J2 (2x2) 20W/25W/30W/35W	2600-4550 lm	130 lm/W	48" x 48"	5.07	120°
CANIS-J2 (1x4) 20W/25W/30W/35W	2600-4550 lm	130 lm/W	12" x 48"	5.51	
CANIS-J2 (2x4) 35W/40W/45W/50W	4550-6500 lm	130 lm/W	24" x 48"	9.26	

*Wattages are adjustable

Photometrics:

CANIS-J2 2x2/5000K

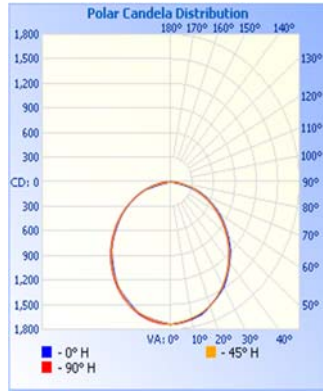

	Center Beam fc	Beam Width	
9.7ft	18.5 fc	29.6 ft	29.4 ft
19.3ft	4.67 fc	58.9 ft	58.5 ft
29.0ft	2.07 fc	88.6 ft	88.0 ft
38.7ft	1.16 fc	118.2 ft	117.4 ft
48.3ft	0.75 fc	147.5 ft	146.5 ft
58.0ft	0.52 fc	177.1 ft	175.9 ft

■ Vert. Spread: 113.6°
■ Horiz. Spread: 113.2°

Dimensions:

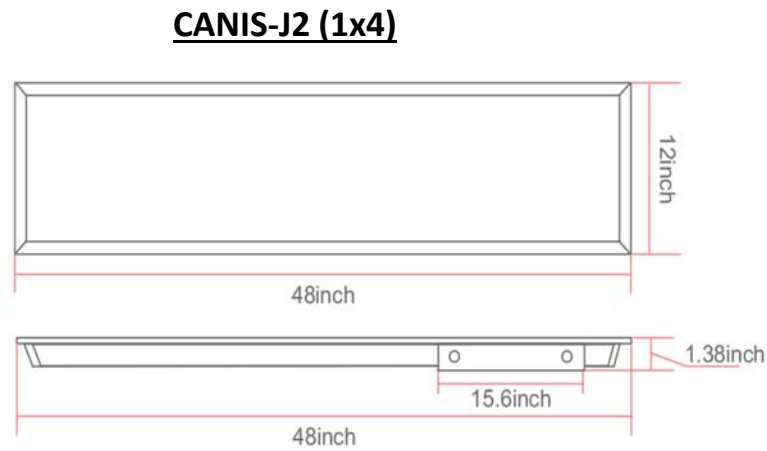
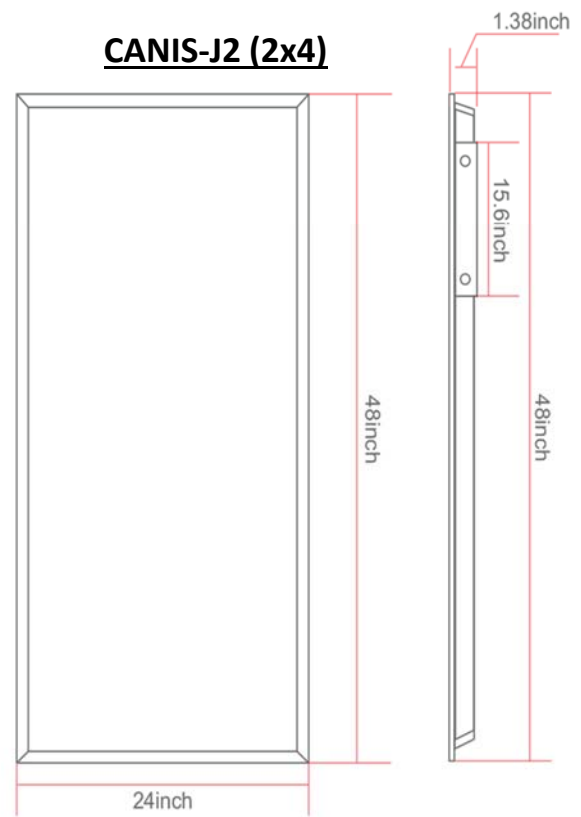
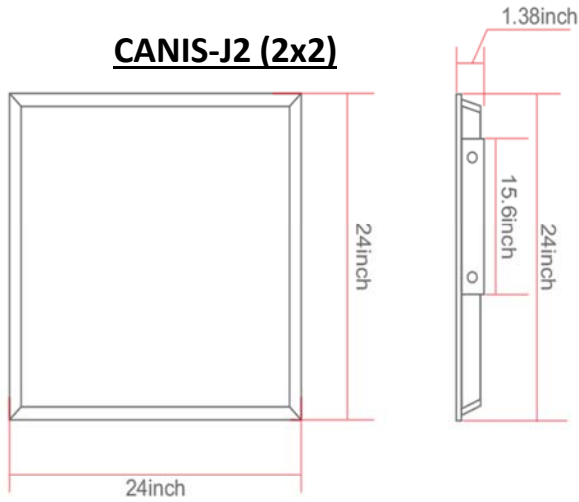

Suspended Mount (Optional):

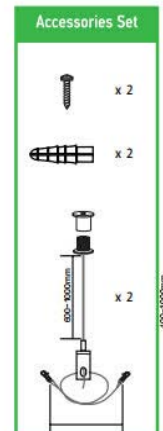
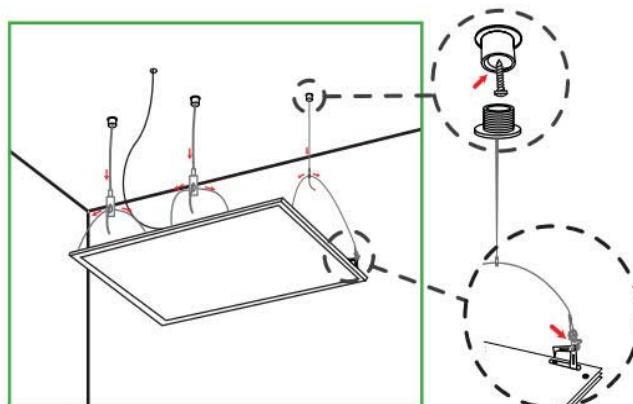





Emergency Battery:

- Rated input voltage (100-277V AC) .
- Meets most safety standards for lighting.
- Main power built-in 3 in 1 dimming function(0-10V/10v PWM/1-100kΩ Resistance).
- Low ripple and noisy, Non-Flicker.
- Main power output current can be regulated by potentionmeter.
- Main power protections : OCP/SCP/OVP.
- Built-in lithium battery as an emergency power supply energy.
- Emergency protections : OVP/LVP SCP/ TVP.
- Intelligent emergency automatic detection function.
- Emergency working time ≥ 90 minute.
- Product warranty: 5 years.



Charged: Red LED  Main Power : Green LED  Malfunction: Yellow LED 

Display status when working

Operating Condition	 Main Power	 Charged	 Malfunction	 Light
Light ON	ON	Slow Flash/OFF	OFF	ON
Emergency work	OFF	ON	OFF	ON
Light OFF	ON / Breathing lamp	Slow flash / OFF	OFF	OFF

1 When the red LED flashes and the green LED lits, indicate that it is on charge.

2 When the red LED went out and the green LED breathe, indicate that electricity is full.

Non normal working state

Operating Condition	 Main Power	 Charged	 Malfunction	 Light
No AC and Battery out	OFF	OFF	OFF	OFF
No AC and Battery low	OFF	Fast Blink	OFF	ON
Battery not Connected	--	--	Fast Blink	--
Power Fault	--	--	ON	OFF



- This product should be installed by trained electricians. Forbid connecting wires when power is on,make power on after make sure that there is no phenomenon of short circuit and the correction is ok.
- The wall switch only controls the main power, no function on emergency lighting.
- Green light-main power, Red light-charging, Yellow light-malfunction; Test: test button
- No indicator works in emergency status.
- Frequently test is prohibited. Each test interval is not less than one minute.

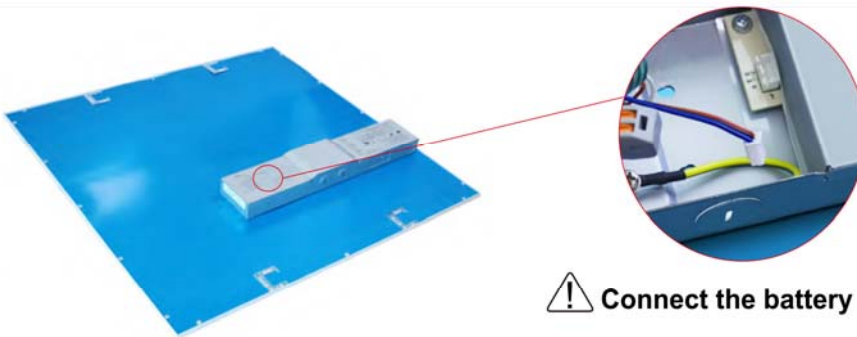

 **Connect the battery plug before wiring.**

Wire connection

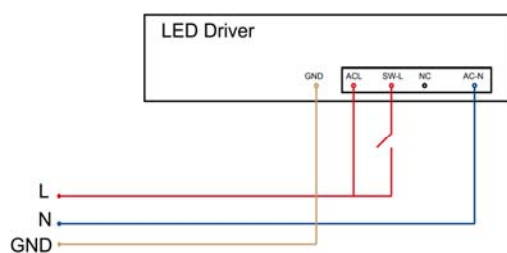

Dimmer Wire connection

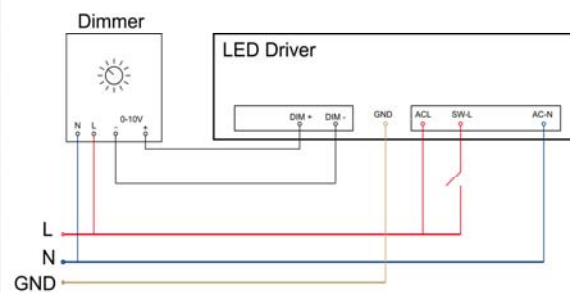

Charging time < 24 hours

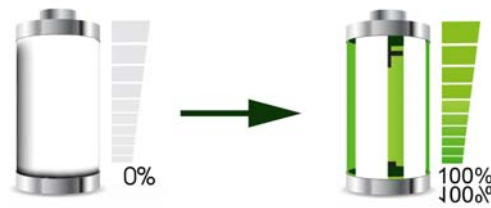

< 24 Hours

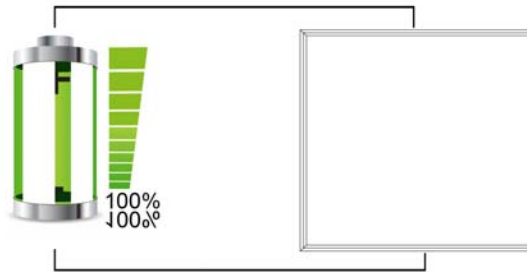

Emergency lighting time ≥ 120mins

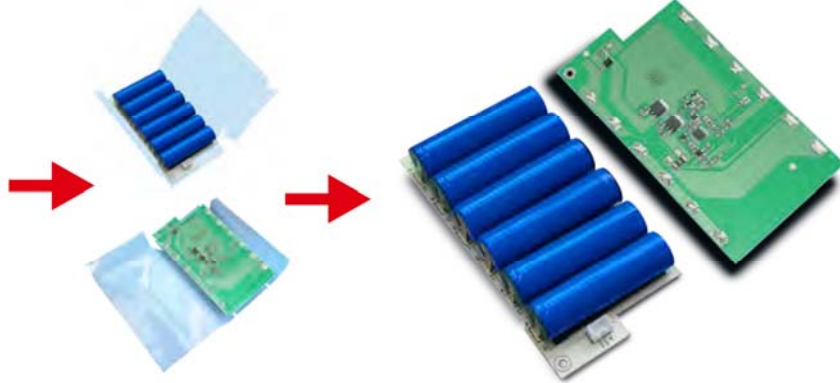
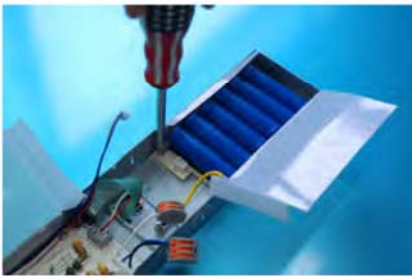

≥ 90 Mins



The battery pack can be disassembled separately with easy replacement, preparing one or more sets as replacements to increase the service life of emergency backup panel.

Battery	Battery capacity	Emergency power Max	Emergency current	Emergency time	Pack rating Voltage	300 cycles of standard CH and standard DC
 4 pcs	2000mA *4	10W	300 mA	≥90minute	14.4V	300cycles
 6 pcs	2000mA *6	17W	500 mA	≥90minute	10.8V	300cycles

Ordering Guide:

CANIS-J2-1X4	120-277V	WH	n/a	Ceiling	DM	120°	
Model: CANIS-J2-2x2 (20W/25W/30W/35W)	Voltage: 120-277V	Mounting Frame Color: WH: White	CCT: Adjustable (3K-4K-45K-5K)	Mounting: Ceiling Recessed Suspended	Dim: DM: 0-10V	Beam Angle: 120°	Optional Accessories: EM: Emergency Battery
CANIS-J2-1x4 (20W/25W/30W/35W)							
CANIS-J2-2x4 (35W/40W/45W/50W)							